

The image features a dark grey background with a white line-art illustration of a Beta reel. In the foreground, a physical Beta reel is shown, which is dark grey with a prominent orange circular cover on its side. The Beta logo and name are embossed on this orange cover. A black cable is plugged into the side of the reel. The background illustration shows the reel's internal components and a larger Beta logo on its side panel.

 **Beta**

**REELS  
CATALOGUE**

**2023**

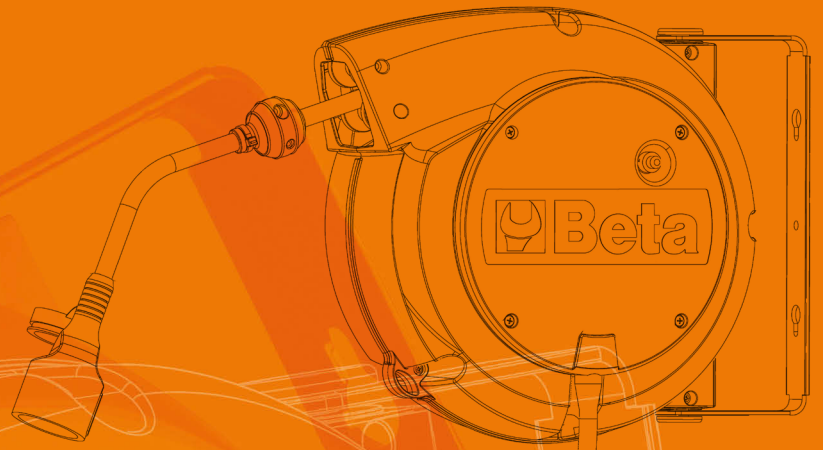

**Beta's new range of hose and cable reels** have been designed and developed to provide users with the widest choice together with durability, practicality and safety in mind.

- A wide range of cable reels in different cables lengths with standard accessories or the possibility to add your own.
- Hose reels that are suitable for the continuous and frequent movement of air as well as water.



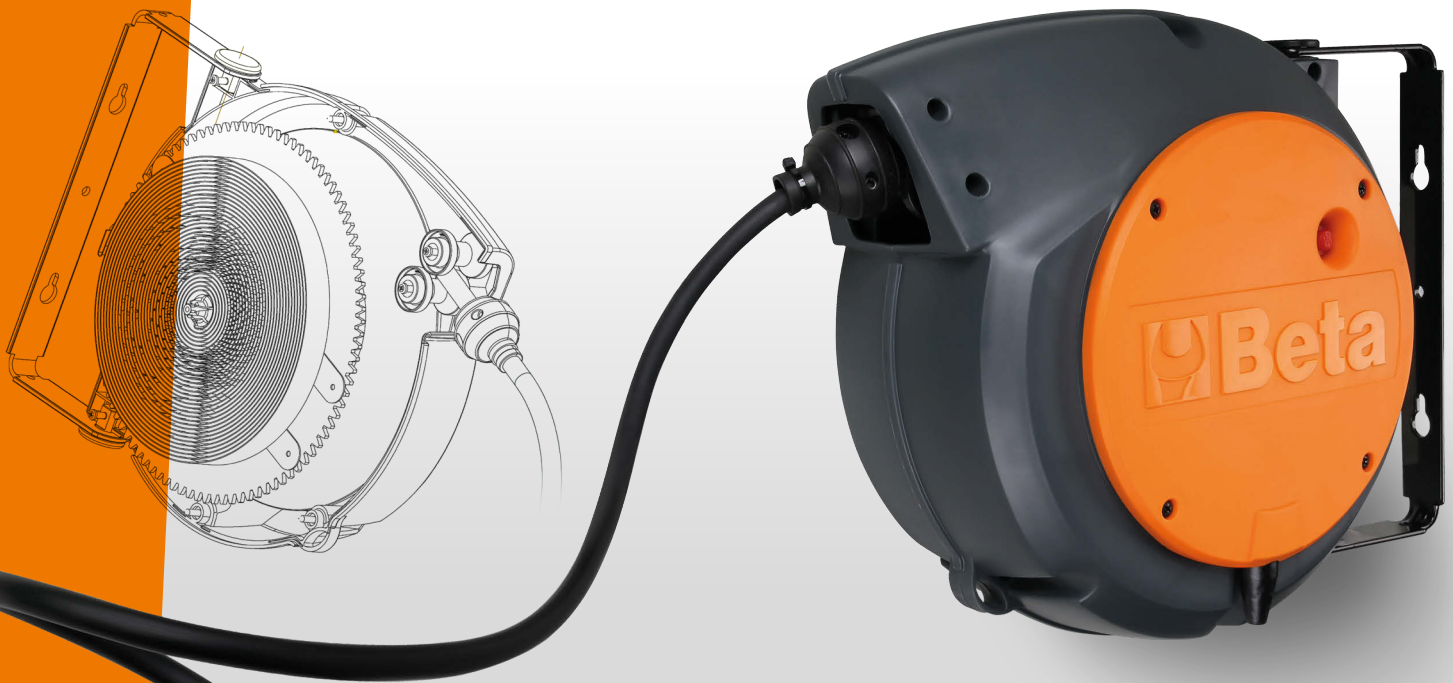

## Impact resistance and durability

Drums made of **thick polypropylene** provide a high levels of shock resistance. High-strength springs ensuring remarkable and unparalleled smoothness. **Cables perfectly rewound and protected**, damage and wear are reduced to a minimum.



## Practicality of use

Rack device causing automatic cable rewind to stop, that can be disabled to allow continuous pulling. The length of the desired hose can be adjusted according to the application.

In addition, each reel is fitted with a **180° swivel wall-mount bracket** and an **additional bracket for quick connection**, and disconnection from, the wall-mount support.

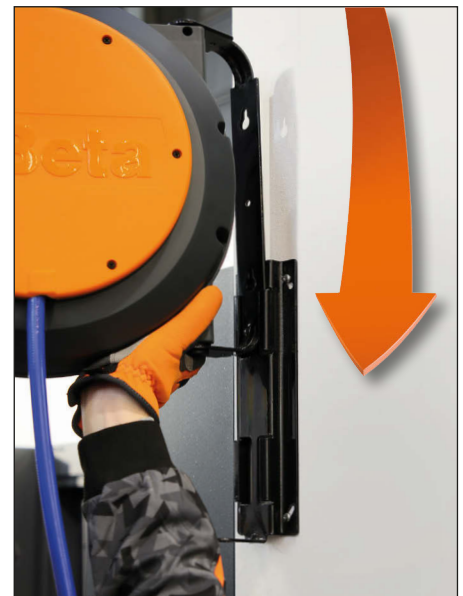

## Order and safety in the workplace













A tidy and safe working environment rounds off the list of benefits. The rewinders ensure an **orderly and efficient workplace**. Cables are in place, ready to be used without wasting valuable time. An orderly equipment is also safe. The user can move around without the risk of tripping over or damaging the equipment itself.



# Key reading







## Electrical cable reels













	Electrical
	Conductors
	Cable length
	Thermal protection
	Coiled/rolled cable power
	Uncoiled/unrolled cable power
	Socket and plug
	LED lamp
	CE standard
	Drum A: Small B: Medium
	Weight
	Code

## Air/water hose reels









	Air
	Water
	Hose length
	Hose diameter
	Fittings
	Temperature
	CE standard
	Drum A: Small B: Medium
	Weight
	Code







## Cable reels

Item	Conductors	Section	Cable type	Cable length	Page
					
 <b>1842</b>	2x	1,0 mm <sup>2</sup>	H05VV-F	15+1,5 m	<b>8</b>
 <b>1843</b>	2x	1,5 mm <sup>2</sup>	H05VV-F	15+1 m	<b>9</b>
 <b>1844</b>	3G	1,5 mm <sup>2</sup>	H05VV-F H07RN-F	10+1 m 15+1 m 30+2 m 14+1 m	<b>10</b>
 <b>1844SCK</b>	3G	1,5 mm <sup>2</sup>	H05VV-F H07RN-F	15+1 m 14+1 m	<b>11</b>
 <b>1845</b>	3G	2,5 mm <sup>2</sup>	H05VV-F H07RN-F	12+1 m 15+1 m 25+1,5 m	<b>12</b>
 <b>1846</b>	4G	1,5 mm <sup>2</sup>	H05VV-F H07RN-F	10+1 m 15+1 m	<b>13</b>
 <b>1847</b>	4G	2,5 mm <sup>2</sup>	H05VV-F H07RN-F	10+1 m 15+1 m	<b>14</b>
 <b>1848</b>	5G	1,5 mm <sup>2</sup>	H05VV-F H07RN-F	10+1 m 15+1 m	<b>15</b>

## Lighting

Item	Cable length				Page
					
 <b>1840BM</b>	10 m				<b>16</b>
 <b>1842LED/BM</b>	10 m				<b>16</b>
 <b>1842LED/ABM</b>	10 m				<b>16</b>
 <b>1846R-LED/BM</b>	X				<b>16</b>

## Hose reels

Item	Ø hose	Hose length			Page
					
 <b>1900S</b>	8 mm	10 m			<b>19</b>
 <b>1900M</b>	8 mm	15 m			<b>20</b>
 <b>1900M</b>	10 mm	15 m			<b>21</b>



# CABLE REELS

A wide range comprising no less than 18 versions, designed to satisfy any working requirements, including the most demanding users'.

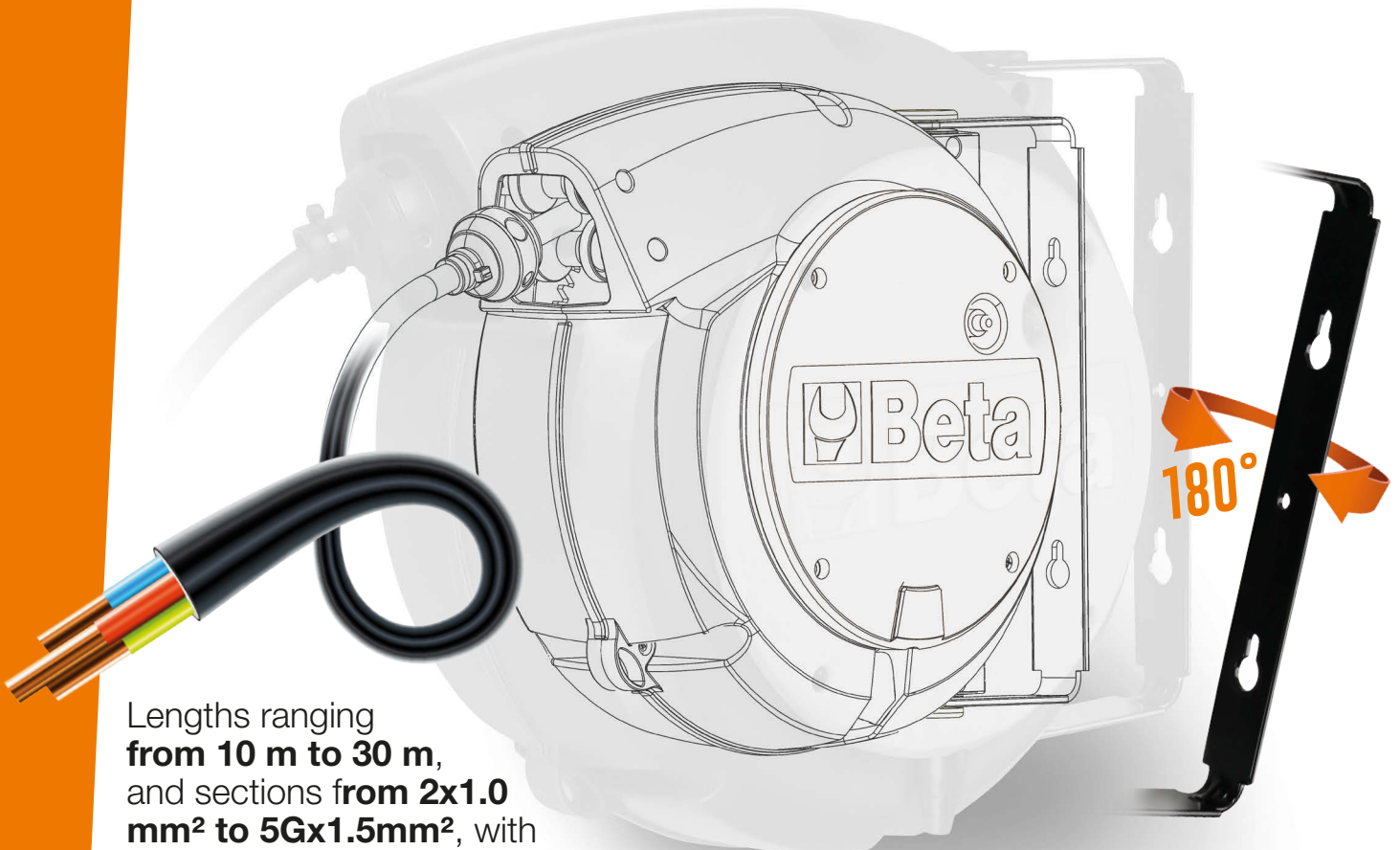

Lengths ranging from 10 m to 30 m, and sections from 2x1.0 mm<sup>2</sup> to 5Gx1.5mm<sup>2</sup>, with H05VV-F and H07RN-F cable types



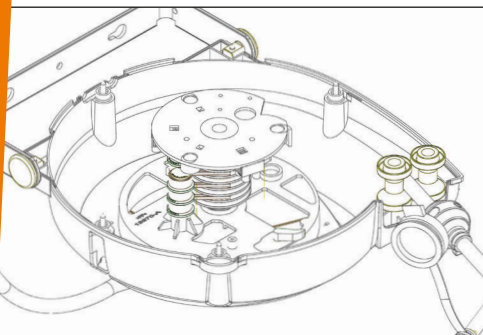

180° swivel wall-mount bracket

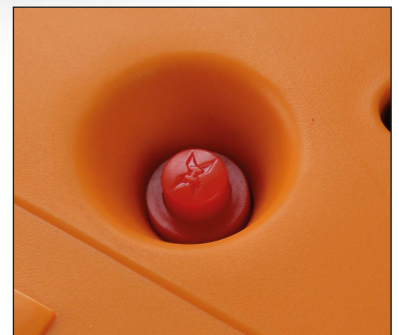

All the cable reels – up to a cable section of 3Gx2.5mm<sup>2</sup> - are supplied with **thermal protection switches**, which are triggered in case of overloading of the electric circuit.





Item	Code 	Conductors 	Section	Cable type	Cable length 	Drum 	Thermal protection 	Accessory
<b>1842 15-H05/LED</b>	<b>018420821</b>	2x	1,0 mm <sup>2</sup>	H05VV-F	15+1 m	A	X	LED lamp
<b>1843 15-H05</b>	<b>018430215</b>	2x	1,5 mm <sup>2</sup>	H05VV-F	15+1 m	A	√	X
<b>1844 10-H05</b>	<b>018440310</b>	3G	1,5 mm <sup>2</sup>	H05VV-F	10+1 m	A	√	X
<b>1844 15-H05</b>	<b>018440315</b>			H05VV-F	15+1 m	A	√	X
<b>1844 30-H05</b>	<b>018440330</b>			H05VV-F	30+2 m	B	√	X
<b>1844 15-H07</b>	<b>018440317</b>			H07RN-F	14+1 m	A	√	X
<b>1844 15-H05/SCK</b>	<b>018440316</b>			H05VV-F	15+1 m	A	√	SCHUKO
<b>1844 15-H07/SCK</b>	<b>018440318</b>	H07RN-F	14+1 m	A	√	SCHUKO		
<b>1845 12-H05</b>	<b>018450365</b>	3G	2,5 mm <sup>2</sup>	H05VV-F	12+1 m	A	√	X
<b>1845 15-H07</b>	<b>018450367</b>			H07RN-F	15+1 m	B	√	X
<b>1845 25-H07</b>	<b>018450377</b>			H07RN-F	25+1,5 m	B	√	X
<b>1846 10-H05</b>	<b>018460405</b>	4G	1,5 mm <sup>2</sup>	H05VV-F	10+1 m	A	X	X
<b>1846 10-H07</b>	<b>018460407</b>			H07RN-F	10+1 m	A	X	X
<b>1846 15-H05</b>	<b>018460415</b>			H05VV-F	15+1 m	A	X	X
<b>1847 10-H05</b>	<b>018470420</b>	4G	2,5 mm <sup>2</sup>	H05VV-F	10+1 m	B	X	X
<b>1847 15-H07</b>	<b>018470427</b>			H07RN-F	15+1 m	B	X	X
<b>1848 10-H05</b>	<b>018480510</b>	5G	1,5 mm <sup>2</sup>	H05VV-F	10+1 m	B	X	X
<b>1848 15-H07</b>	<b>018480517</b>			H07RN-F	15+1 m	B	X	X

Automatic cable reel with LED inspection lamp, 100-240Vac

# 1842



CE IP42 IP65

**Features:**

- With 230/12V safety transformer
- H05VV-F 2x1.0 mm<sup>2</sup> cable
- Coiled cable length: 15 m
- 1.5 m incoming cable with SCHUKO type socket
- Length of cable out of drum: 1 m
- Rack mechanism can be disabled to keep cable pulled
- Supplied with a 180° swivel bracket and an additional quick connection bracket

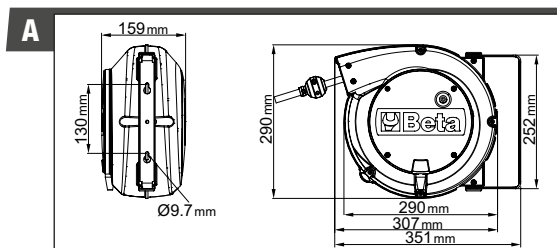

Item	Conductors	Section	Cable type	Cable length	Thermal protection	Accessory	Weight	Code
<b>1842 15-H05/LED</b>	2x	1,0 mm <sup>2</sup>	H05VV-F	15+1 m	X	Led Lamp	3,80	<b>018420821</b>



Automatic cable reel,  
with 2x1.5 mm<sup>2</sup> cable

# 1843



CE IP42 □

### Features:

- H05VV-F 2x1,5 mm<sup>2</sup> cable
- With thermal protection switch
- Coiled cable length: 15 m
- Cable length out of drum: 1 m
- Supplied without incoming cable
- Rack mechanism can be disabled to keep cable pulled
- Max. power (rolled up): 1300W (230V-20°C)
- Max. power (unrolled): 2300W (230V-20°C)
- Supplied with a 180° swivel bracket and an additional quick connection bracket

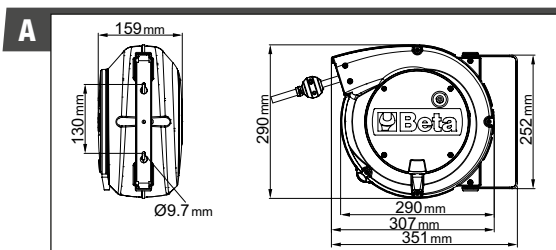

Item	Conductors	Section	Cable type	Cable length	Thermal protection	W 230V-20°C	W 230V-20°C	Weight	Code
<b>1843 15-H05</b>	2x	1,5 mm <sup>2</sup>	H05VV-F	15+1 m	✓	1300	2300	4,20	<b>018430215</b>

Automatic cable reel,  
with 3Gx1.5 mm<sup>2</sup> cable

# 1844



CE IP42

### Features:

- 3Gx1.5 mm<sup>2</sup> cable
- With thermal protection switch
- Cable length out of drum: 1 m (except for 1844 30-H05, 2 m)
- Supplied without incoming cable
- Rack mechanism can be disabled to keep cable pulled
- Max. power (rolled up): 1500W (230V-20°C)
- Max. power (unrolled): 2500W (230V-20°C)
- Supplied with a 180° swivel bracket and an additional quick connection bracket

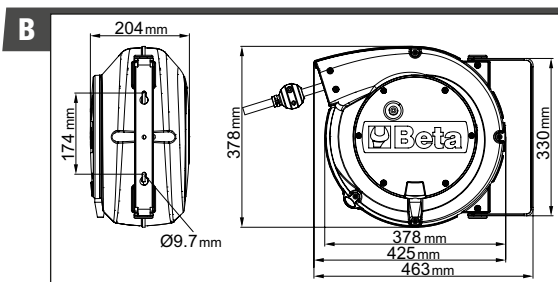
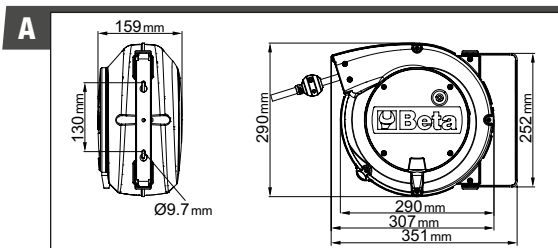

Item	Conductors	Section	Cable type	Cable length	Thermal protection	W 230V-20°C	W 230V-20°C	Drum	Weight	Code
<b>1844 10-H05</b>	3G	1,5 mm <sup>2</sup>	H05VV-F	10+1 m	✓	1500	2500	A	3,90	<b>018440310</b>
<b>1844 15-H05</b>	3G	1,5 mm <sup>2</sup>	H05VV-F	15+1 m	✓	1500	2500	A	4,60	<b>018440315</b>
<b>1844 30-H05</b>	3G	1,5 mm <sup>2</sup>	H05VV-F	30+2 m	✓	1500	2500	B	9,70	<b>018440330</b>
<b>1844 15-H07</b>	3G	1,5 mm <sup>2</sup>	H07RN-F	14+1 m	✓	1500	2500	A	5,20	<b>018440317</b>

Automatic cable reel, with 3Gx1.5 mm<sup>2</sup> cable and SCHUKO type socket

# 1844SCK



CE IP42

## Features:

- 3Gx1.5 mm<sup>2</sup> cable
- With thermal protection switch
- Length of cable out of drum: 1 m with **SCHUKO** type socket
- Supplied with 1.5 m incoming cable and **SCHUKO** type socket
- Rack mechanism can be disabled to keep cable pulled
- Max. power (rolled up): 1500W (230V-20°C)
- Max. power (unrolled): 2500W (230V-20°C)
- Supplied with a 180° swivel bracket and an additional quick connection bracket

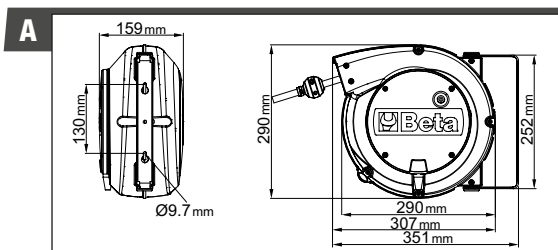

Item	Conductors	Section	Cable type	Cable length	Thermal protection	W 230V-20°C	W 230V-20°C	Socket and plug	Weight	Code
<b>1844 15-H05/SCK</b>	3G	1,5 mm <sup>2</sup>	H05VV-F	15+1 m	✓	1500	2500	Schuko	5,00	<b>018440316</b>
<b>1844 15-H07/SCK</b>	3G	1,5 mm <sup>2</sup>	H07RN-F	14+1 m	✓	1500	2500	Schuko	5,70	<b>018440318</b>

Automatic cable reel,  
with 3Gx2.5 mm<sup>2</sup> cable

# 1845



CE IP42

**Features:**

- 3Gx2.5 mm<sup>2</sup> cable
- With thermal protection switch
- Cable length out of drum: 1 m (except for 1845 25-H07RN-F, 1.5 m)
- Supplied without incoming cable
- Rack mechanism can be disabled to keep cable pulled
- Max. power (rolled up): 2000W (230V-20°C)
- Max. power (unrolled): 3000W (230V-20°C)
- Supplied with a 180° swivel bracket and an additional quick connection bracket

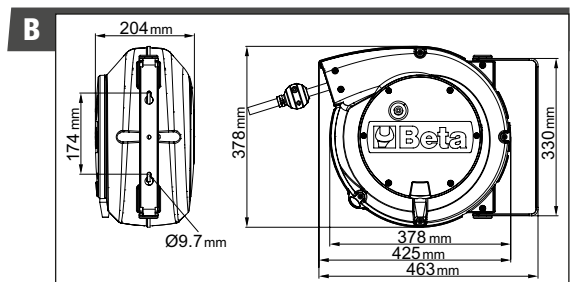
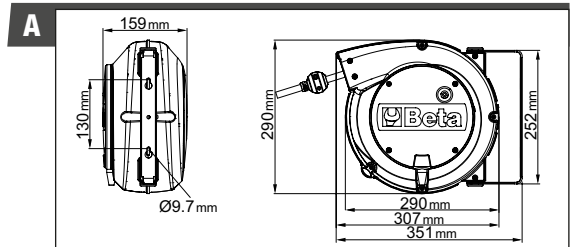

Item	Conductors	Section	Cable type	Cable length	Thermal protection	W 230V-20°C	W 230V-20°C	Drum	Weight	Code
1845 12-H05	3G	2,5 mm <sup>2</sup>	H05VV-F	12+1 m	✓	2000	3000	A	4,90	018450365
1845 15-H07	3G	2,5 mm <sup>2</sup>	H07RN-F	15+1 m	✓	2000	3000	B	8,30	018450367
1845 25-H07	3G	2,5 mm <sup>2</sup>	H07RN-F	25+1,5 m	✓	2000	3000	B	11,00	018450377

Automatic cable reel,  
with 4Gx1.5 mm<sup>2</sup> cable

# 1846



CE IP42 □

### Features:

- 4Gx1.5 mm<sup>2</sup> cable
- Without thermal protection switch
- Cable length out of drum: 1 m
- Supplied without incoming cable
- Rack mechanism can be disabled to keep cable pulled
- Max. power (rolled up): 1400W (230V-20°C)
- Max. power (unrolled): 1900W (230V-20°C)
- Supplied with a 180° swivel bracket and an additional quick connection bracket

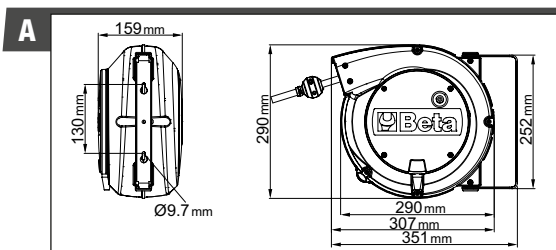

Item	Conductors	Section	Cable type	Cable length	Thermal protection	W 400V-20°C	W 400V-20°C	Weight	Code
<b>1846 10-H05</b>	4G	1,5 mm <sup>2</sup>	H05VV-F	10+1 m	X	1400	1900	4,40	<b>018460405</b>
<b>1846 10-H07</b>	4G	1,5 mm <sup>2</sup>	H07RN-F	10+1 m	X	1400	1900	5,20	<b>018460407</b>
<b>1846 15-H05</b>	4G	1,5 mm <sup>2</sup>	H05VV-F	15+1 m	X	1400	1900	5,40	<b>018460415</b>

Automatic cable reel,  
with 4Gx2.5 mm<sup>2</sup> cable

# 1847



CE IP42

**Features:**

- 4Gx2.5 mm<sup>2</sup> cable
- Without thermal protection switch
- Length of cable out of drum: 1 m
- Supplied without incoming cable
- Rack mechanism can be disabled to keep cable pulled
- Max. power (rolled up): 2000W (230V-20°C)
- Max. power (unrolled): 2700W (230V-20°C)
- Supplied with a 180° swivel bracket and an additional quick connection bracket

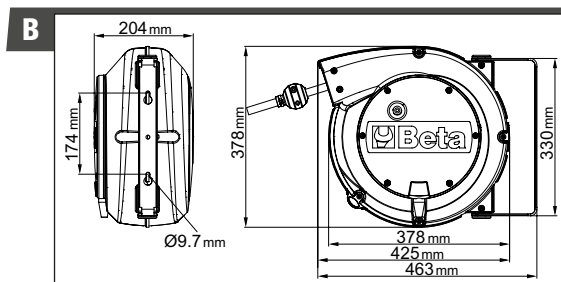

Item	Conductors	Section	Cable type	Cable length	Thermal protection	W 400V-20°C	W 400V-20°C	Weight	Code
<b>1847 10-H05</b>	4G	2,5 mm <sup>2</sup>	H05VV-F	10+1 m	X	2000	2700	6,70	<b>018470420</b>
<b>1847 15-H07</b>	4G	2,5 mm <sup>2</sup>	H07RN-F	15+1 m	X	2000	2700	8,80	<b>018470427</b>

Automatic cable reel,  
with 5Gx1.5 mm<sup>2</sup> cable

# 1848



CE IP42

### Features:

- 5Gx1.5 mm<sup>2</sup> cable
- Without thermal protection switch
- Length of cable out of drum: 1 m
- Supplied without incoming cable
- Rack mechanism can be disabled to keep cable pulled
- Max. power (rolled up): 1400W (230V-20°C)
- Max. power (unrolled): 1900W (230V-20°C)
- Supplied with a 180° swivel bracket and an additional quick connection bracket

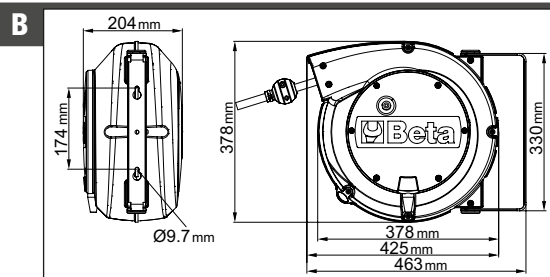

Item	Conductors	Section	Cable type	Cable length	Thermal protection	W 400V-20°C	W 400V-20°C	Weight	Code
<b>1848 10-H05</b>	5G	1,5 mm <sup>2</sup>	H05VV-F	10+1 m	X	1400	1900	6,40	<b>018480510</b>
<b>1848 15-H07</b>	5G	1,5 mm <sup>2</sup>	H07RN-F	15+1 m	X	1400	1900	8,60	<b>018480517</b>

230V inspection lamp,  
base type: E27

# 1840BM

CE IP20

**Features:**

- 10-m-long cable
- 230V
- Bulb not included



230V

Item	Cable length	Code
1840BM	10 m	018400101

Lamp with ultra-high  
brightness LEDs, 100-240 Vac

# 1842LED/BM

CE IP65

**Features:**

- 10-m-long cable
- Compact body made of antislip rubber
- Easy-to-replace front glass
- Swinging hook
- 340 lumens
- With multi-directional head LED light



100/240V



Item	Cable length	Code
1842LED/BM	10 m	018420301

Lamp with ultra-high  
brightness LEDs, 12-24V AC/DC

# 1842LED/ABM

CE IP65

**Features:**

- 10-m-long cable
- Compact body made of antislip rubber
- Easy-to-replace front glass
- Swinging hook
- 340 lumens
- With multi-directional head LED light



24V



Item	Cable length	Code
1842LED/ABM	10 m	018420311

Spare LED lamps,  
12-24V AC/DC

# 1846R-LED/BM

CE IP65

**Features:**

- 12-24V AC/DC
- Compact body made of antislip rubber
- Easy-to-replace front glass
- Swinging hook
- 340 lumens
- With multi-directional head LED light



Item	Code
1846R-LED/BM	018460331







# HOSE REELS

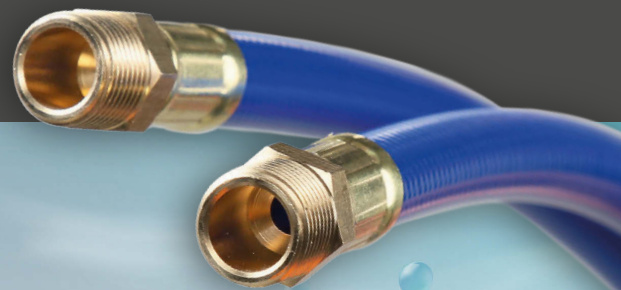

**A selected range**, with lengths ranging from 10 m to 15 m, 8 mm and 10 mm in diameter, for use with pneumatic tools. **Since our products are leak-proof, they can also be used with water.**

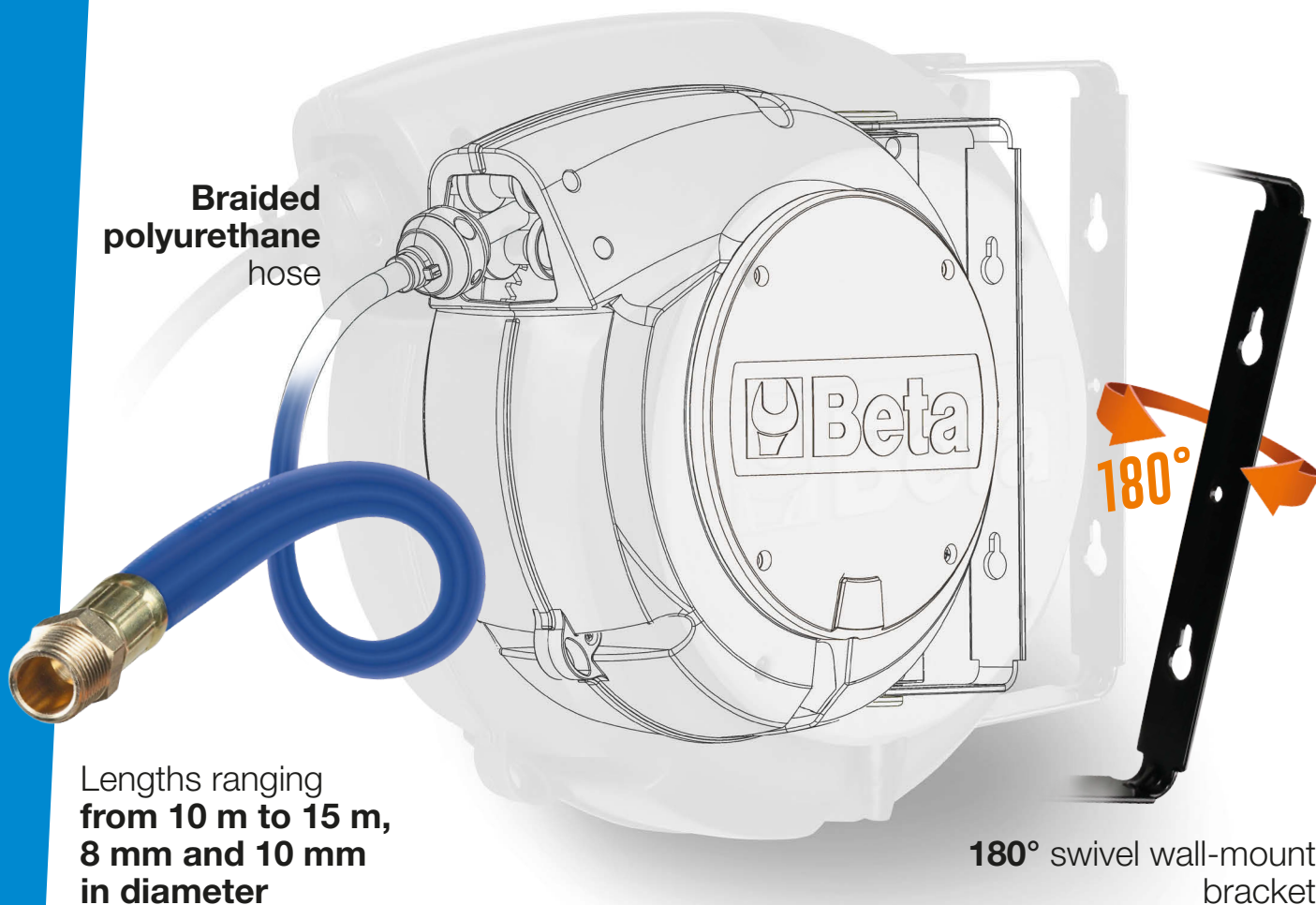

**Braided polyurethane hose**

Lengths ranging from **10 m to 15 m**, **8 mm and 10 mm** in diameter

**180°** swivel wall-mount bracket

Item	Code	Ø hose	Hose length	Drum	Fittings	Air	Water
<b>1900S 8x10</b>	<b>019000080</b>	8 mm	10 m	A	1/4"	✓	✓
<b>1900M 8x15</b>	<b>019000085</b>	8 mm	15 m	B	1/4"	✓	✓
<b>1900M 10x15</b>	<b>019000115</b>	10 mm	15 m	B	3/8"	✓	✓

Automatic spring hose reel,  
with 8x10 mm hose

# 1900S

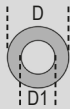

CE

### Features:

- Automatic hose reel, shockproof plastic body, **for air or water**
- Max. operating pressure: 15 bar
- Braided polyurethane hose
- Polypropylene frame
- Device for automatically fixing hose at required length
- Rack mechanism can be disabled to keep hose pulled
- Water operating temperature range: -5 °C / +50 °C
- Supplied with a 180° swivel bracket and an additional quick connection bracket

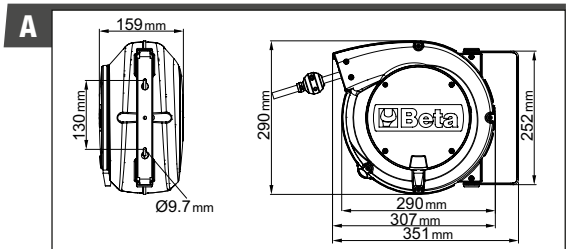

Item	Ø hose D1xD	Hose length	Fitting	Fitting	Max. operating pressure	Max. temperature	Air	Water	Weight	Code
<b>1900S 8x10</b>	8x10 mm	10 m	1/4"	1/4"	15 bar	50°C	√	√	3,90	<b>019000080</b>

Automatic spring hose reel,  
with 8x15 mm hose

**1900M** 8x15

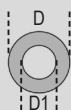

CE

**Features:**

- Automatic hose reel, shockproof plastic body, **for air or water**
- Max. operating pressure: 15 bar
- Braided polyurethane hose
- Polypropylene frame
- Device for automatically fixing hose at required length
- Rack mechanism can be disabled to keep hose pulled
- Water operating temperature range: -5 °C / +50 °C
- Supplied with a 180° swivel bracket and an additional quick connection bracket

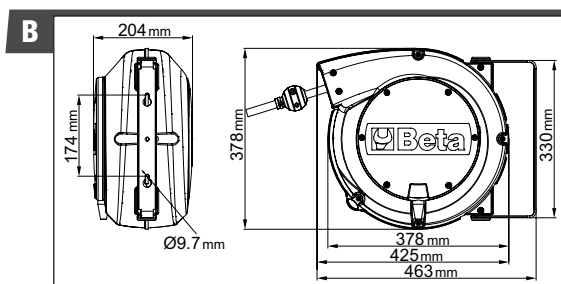

Item	Ø hose D1xD	Hose length	Fitting	Fitting	Max. operating pressure	Max. temperature	Air	Water	Weight	Code
<b>1900M 8X15</b>	8x15 mm	15 m	1/4"	1/4"	15 bar	50°C	✓	✓	6,00	<b>019000085</b>

Automatic spring hose reel,  
with 10x15 mm hose

**1900M**<sup>10x15</sup>

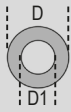

CE

**Features:**

- Automatic hose reel, shockproof plastic body, **for air or water**
- Max. operating pressure: 15 bar
- Braided polyurethane hose
- Polypropylene frame
- Device for automatically fixing hose at required length
- Rack mechanism can be disabled to keep hose pulled
- Water operating temperature range: -5 °C / +50 °C
- Supplied with a 180° swivel bracket and an additional quick connection bracket

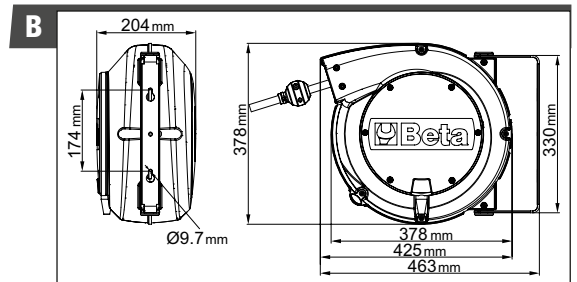

Item	Ø hose D1xD	Hose length	Fitting	Fitting	Max. operating pressure	Max. temperature	Air	Water	Weight	Code
<b>1900M 10X15</b>	10x15 mm	15 m	3/8"	3/8"	15 bar	50°C	✓	✓	6,80	<b>019000115</b>



## **ORDER AND SAFETY IN THE WORKPLACE!**

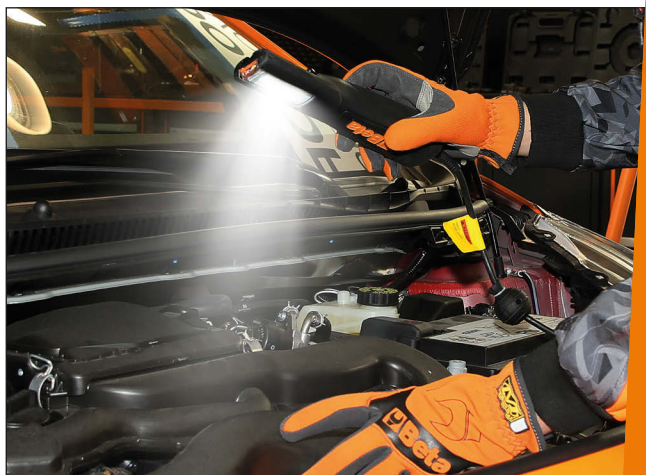



099804602

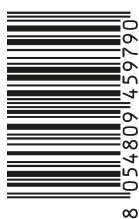

8 054809 459790



**Beta**  
www.beta-tools.com



Beta Utensili S.p.A.  
Via Volta, 18 - 20845 Sovico (MB)  
ph. +39 039 20771  
**www.beta-tools.com**

The images are for reference only. Beta Utensili S.p.A. reserves the right to update and upgrade its product range without notice.